

**NO. QUESTION**

1 Five books were placed on a shelf. The titles of the books were Lord of the Flies, The Odyssey, Hamlet, Macbeth, and Romeo and Juliet. Five students namely David, Lex, Vina, Kia, and Jay were assigned only one book to read by the teacher, and the book assigned by each student follows these conditions:

- Kia and Jay did not get Lord of the Flies.
- Hamlet was assigned to David.
- The teacher assigned Macbeth to Vina.
- Kia did not get Romeo and Juliet.

**Which of the following statements is true?**

- A. The Lord of the Flies was assigned to David.
- B. Kia was not assigned to read The Odyssey
- C. Hamlet was assigned to Vina.
- D. Romeo and Juliet was assigned to Jay.

2

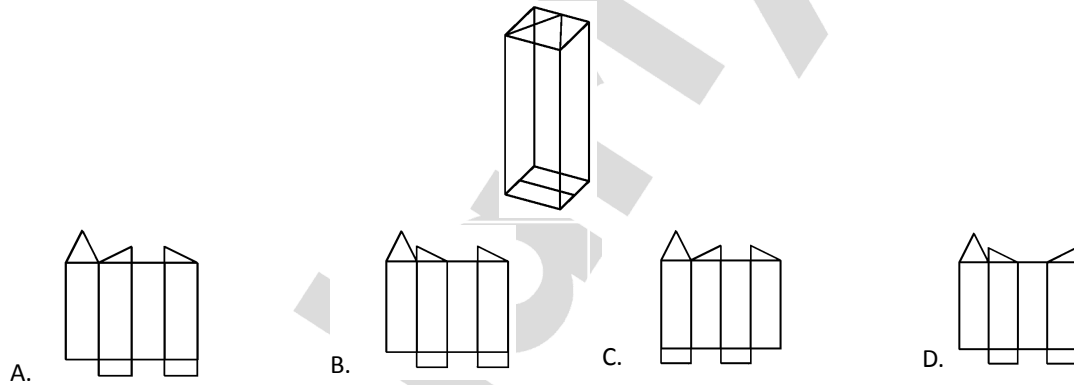

3 Brit and Ivy send messages in letters instead of words. Rodney wants to learn Brit's and Ivy's codes. He was able to read four of the messages and he was confident of the meaning of the messages.

Messages	Meaning
U Y E F G	The science experiment was beautiful.
F Y U P O L M	Some of the experiment was a disaster.
G N M A	Science education is important.
D J K Y	We conducted an experiment.

**Which letter represents the word "Science"?**

- A. A
- B. Y
- C. G
- D. F

4 A certain school offered 3 different clubs to be participated in by students - English Club, Math Club, and Science Club. Mary, Suzette, Jacob, John, Vanessa, and Jan decided and agreed to join at least one of the clubs. They joined the clubs according to the following conditions.

- John did not join the club where Jan was.
- Suzette did not join the English Club.
- There were 3 students who joined the Math Club.
- Mary, Jacob, and exactly two other students joined the Science Club.
- Suzette and Vanessa joined exactly one club.
- Jan joined more clubs than Vanessa.
- Jan joined the English and Math Club.

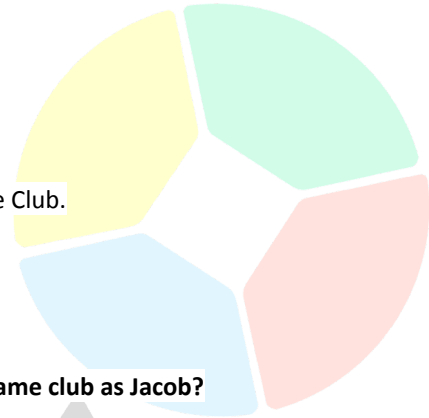

**What is the highest possible number of people who have joined the same club as Jacob?**

- A. Two
- B. Three
- C. Four
- D. Five

5 Recent studies have shown that the United States is facing a shortage of affordable housing, with millions of households spending more than 30% of their income on rent. In fact, a recent report indicates that the country needs at least 7 million more affordable and available rental homes to meet the demand. This shortage has far-reaching consequences, including increased homelessness, housing insecurity, and poverty.

**Which of the following, if true, most strengthens the argument?**

- A. Many cities have implemented rent control policies to make housing more affordable.
- B. The average household income in the United States has increased over the past decade.
- C. Access to affordable housing has been shown to have positive impacts on health and education.
- D. The construction of new affordable housing units has increased significantly in recent years

6 In order to prevent litter, a city park is surrounded by rubbish bins. Some city council members favour steel rubbish bins, while others favour rubber, but both kinds are present on the border of the park. One rubbish bin that is either rubber or steel is present at each point in the following diagram of the park:

The type of rubbish bin that is present at each of the six points is governed by the following conditions.

1. Each steel rubbish bin must be adjacent to at least one other rubber rubbish bin.
2. The rubbish bin on the southwest corner is rubber.
3. The rubbish bin in the middle of the north side is steel.
4. Three rubbish bins on the corners must be rubber.
5. Only one steel rubbish bin is adjacent to another steel rubbish bin and it is on the southside.
6. A rubber rubbish bin on a corner of the park must be adjacent to another rubber rubbish bin.

**If the rubbish bin in the middle of the south side is steel, then which of the following must be true?**

- A. The rubbish bin on the northeast corner is steel.
- B. The rubbish bin on the southeast corner is steel.
- C. The rubbish bin on the northwest corner is steel.
- D. None of the above.

7 There were six stations in a science caravan school tour – Sprout House, Kinetic Sand, Craft Stick Catapult, Galaxy in a Bottle, 3D Glasses, and Homemade Spectroscope. After visiting each station, each person gets at least one of the three freebies given: bubbles, marbles, and cards. The following restrictions are considered upon giving the freebies.

The students stop at Sprout House either immediately before or immediately after 3D Glasses.

The students get marbles and cards at Galaxy in a Bottle and stop at Galaxy in a Bottle first.

The students get bubbles at exactly four stations.

The students go to Kinetic Sand last.

The students get more freebies at Kinetic Sand than in Craft Stick Catapult, and more freebies at the last station than at the first station at which they stopped.

The students stop at Kinetic Sand either immediately before or immediately after Craft Stick Catapult, and stops at Sprout House before Kinetic Sand.

**If the students stop at Homemade Spectroscope before the 3D Glasses station, which of the following statements must be true?**

- A. Craft Stick Catapult is fifth on the stations.
- B. 3D glasses are third on the stations.
- C. Sprout House is third on the stations.
- D. Kinetic Sand is fifth on the stations.

8 Shown below is a nutritional fact of a chicken breast.

<b>Nutrition Facts</b>	
Cooked, Boneless, Skinless Chicken Breast	
Serving Size	6 oz
<b>Calories</b>	<b>240</b>
<b>Total Fat</b>	3g
Saturated Fat	0g
Cholesterol	130mg
Sodium	84mg
Potassium	0mg
<b>Total Carbs</b>	0g
Dietary Fiber	0g
Sugars	0g
<b>Protein</b>	53g
Calcium	0%
Iron	0%
<small>*based on MyFitnessPal nutrition database, compiled by bodybuildingmealplan.com</small>	

Gen wanted to create a dish from chicken breast for the whole family. Its serving size was 21oz. Based on the nutrition facts shown above, how many mg of cholesterol and sodium were contained in the dish?

- A. 435mg of Cholesterol and 284mg of Sodium
- B. 455mg of Cholesterol and 294mg of Sodium
- C. 455mg of Cholesterol and 284mg of Sodium
- D. 435mg of Cholesterol and 294mg of Sodium

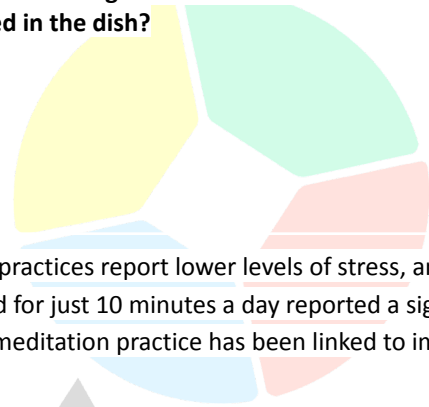

- 9 Research has shown that individuals who engage in regular meditation practices report lower levels of stress, anxiety, and depression. In fact, a recent study found that individuals who meditated for just 10 minutes a day reported a significant decrease in symptoms of anxiety and depression. Additionally, regular meditation practice has been linked to improved cognitive function and increased feelings of well-being.

Which of the following, if true, most strengthens the argument?

- A. Meditation has been shown to reduce the risk of developing certain chronic health conditions, such as heart disease and diabetes.
- B. Many workplaces have implemented mindfulness programs to improve employee well-being and productivity.
- C. Individuals who meditate regularly tend to have stronger social connections and support networks.
- D. Meditation has been shown to improve sleep quality and reduce the incidence of insomnia.

10

A recent study conducted on a sample of 1,000 university students showed that those who regularly used smartphones in the class had lower grades than those who did not use them. The study found that students who used their phones for non-academic purposes during class time scored an average of 20% lower on exams than students who did not use their phones at all. Sarah: "Using smartphones is the only reason for the decline in academic performance, and students who do not use them have better grades."

Sarah found this



Sarah: "Using smartphones is the only reason for the decline in academic performance, and students who do not use them have better grades."

Which among the options best describes the flaw in Sarah's statement?

- A. Sarah assumes that all students in the sample group used smartphones during class, ignoring those who did not.
- B. Sarah's statement suggests that the study's findings are unreliable and not credible.
- C. Sarah's statement overlooks the fact that there may be other factors that contribute to a decline in academic performance, such as attendance and study habits.
- D. Sarah's statement implies that not using smartphones in class guarantees academic success, which is not necessarily true.

- 11 In a scrabble tournament, each player is given a tracker number after registration. The tracker number is composed of three cards, wherein each card contains a number from 0 to 9, depending upon registration. The first participant received a tracker number 001.

An example of the player's card is shown below.

0	2	9
---	---	---

369 players registered in the said tournament.

**How many cards containing the number 4 will be needed?**

- A. 76
- B. 77
- C. 67
- D. 66



- 12 A farmer planted 3 different kinds of crops – corn, wheat, and soybeans. The farmer planted these crops in six different soils. Each soil contained at least one of the crops. The crops are planted in the soil according to the following conditions.

- Corn and wheat were planted on the second soil.
- On the fourth soil, neither corn nor soybeans were planted on it.
- The second and fifth soil have exactly two crops planted in common.
- The fifth soil has exactly one less crop planted inside it than the last soil, and it does not have soybeans planted on it.
- Any of the soil that has soybeans in it also has wheat in it.
- Corn is planted in exactly 5 soils.

**If only four soils have wheat planted in them, then each of the following must be true EXCEPT:**

- A. The second soil does not have soybeans planted in it.
- B. The first soil has corn.
- C. The third soil has corn.
- D. The third soil does not have wheat planted in it.

- 13 Current events and historical programming can help make young people more aware of what is happening in other cultures and among other people. As a result, we act and make decisions based on our perceptions of the world. It is beneficial to require children to watch the news on television since everything they see is factual.

**Which of the following statements best weakens the above argument?**

- A. Allowing children to watch the news would only cause them stress at a young age.
- B. Reading the news in newspapers would better enhance their analysis skills.
- C. Some of the information in the TV news may not be true due to media bias.
- D. People and their culture can be studied better in schools and libraries.

14 **Situation:** A student chooses to attend an Ivy League university instead of a less prestigious university even though the latter offered them a full scholarship.

**Analysis:** Some people prioritise prestige and status over practical considerations such as financial savings.

Which of the following situations is most consistent with the analysis provided above?

- A. A person buys a luxury car even though they can only afford the monthly payments by sacrificing other expenses such as rent and utilities.
- B. A person chooses to attend a community college for two years to save money on tuition before transferring to a four-year university.
- C. A person chooses to pursue a degree in a field with higher earning potential even though they have a strong passion for a different field with lower earning potential.
- D. A person chooses to live in an expensive city to be closer to job opportunities even though they could save money by living in a more affordable area and commuting.

15 **Which component shapes can be made from the component parts?**

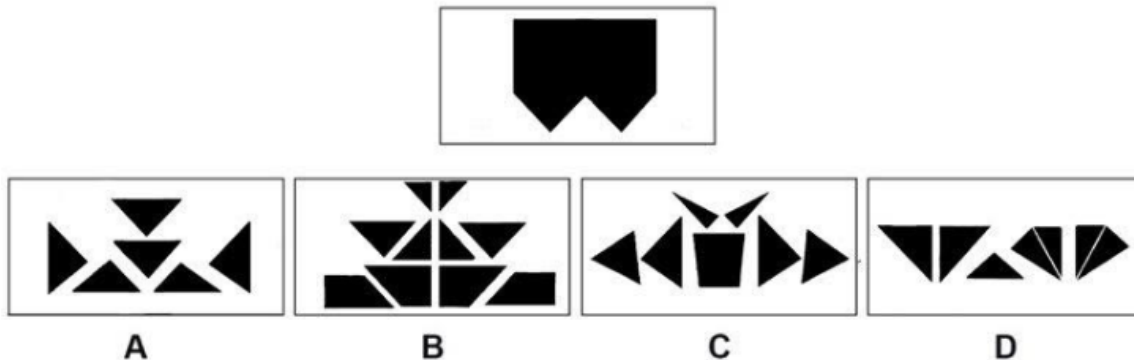

16 **Situation:** A person spends \$10,000 on a limited-edition watch even though they already own several functional watches.

**Analysis:** Some people prioritise the value of exclusive items over practical considerations such as cost-effectiveness.

Which of the following situations is most consistent with the analysis provided above?

- A. A person buys a designer dress for a wedding, even though they can only wear it once and it costs a significant portion of their monthly salary.
- B. A person chooses to buy a generic brand of medication instead of a name-brand medication, even though the name-brand medication is known to be more effective.
- C. A person chooses to buy a used car instead of a new car to save money and avoid high depreciation costs.
- D. A person chooses to buy a house in a prestigious neighbourhood even though it is significantly over their budget.

- 17 The consumption of sugary drinks has been linked to a number of health problems, including obesity, diabetes, and tooth decay. In particular, children who consume sugary drinks on a regular basis are more likely to develop these health problems. Despite the known negative health effects, sugary drinks remain popular, and their consumption continues to increase in many parts of the world.

Which of the following best summarises the main point of the passage?

- A. Sugary drinks are a leading cause of obesity, diabetes, and tooth decay.
- B. The consumption of sugary drinks is most harmful to children's health.
- C. Despite their negative health effects, sugary drinks remain popular and their consumption is on the rise.
- D. Governments should introduce measures to reduce the availability and consumption of sugary drinks.

18

A recent study found that people who eat breakfast regularly have a lower risk of developing type 2 diabetes compared to those who skip breakfast. The study analysed a sample of 5,000 adults and found that those who ate breakfast at least five times a week had a 30% lower risk of developing type 2 diabetes than those who skipped breakfast.



Bob: "I never eat breakfast, so I'm going to get type 2 diabetes."

Which among the options best describes the flaw in Bob's statement?

- A. Bob assumes that all adults in the sample group never ate breakfast, ignoring those who did.
- B. Bob's statement suggests that the study's findings are unreliable and not credible.
- C. Bob's statement implies that not eating breakfast guarantees the development of type 2 diabetes, which is not necessarily true.
- D. Bob's statement overlooks the fact that there may be other factors that contribute to the development of type 2 diabetes, such as family history and physical activity.

- 19 To be able to open the laboratory's money machine, a five-digit code must be done and could be unlocked using the following rules:

- The codes involve numbers 0, 3, 6, 7, 9, and no others.
- The value of the third digit is less than that of the fifth.
- The second digit has a value twice that of the first.
- Each number could not be repeated.

If the third digit of the code is not 6, then which one of the following must be true?

- A. The second digit of the code is 7.
- B. The third digit of the code could be 0 or 7.
- C. The first digit of the code could be 7 or 9.
- D. The fifth digit of the code is 3.

- 20 The volleyball team wanted to purchase 7 pieces of Jersey shirts. The team contacted four different suppliers with discount offers:

Suppliers	DISCOUNT OFFERS
Go Tees	Buy 1 take 2 for \$260 per piece.
Artistic Stitch	Buy 2 take 1 for \$150 per piece
Tee Time	20% of the final total price at \$230 per piece.
Tee Apparel	Buy 5 at 25% off at a price of \$180 per piece

Where should the team buy their jersey if they want the cheapest cost?

- A. Tee Time
  - B. Tea Apparel
  - C. Artistic Stitch
  - D. Go Tees
- 21 Globalisation has been praised for its ability to increase economic growth and bring people from different cultures closer together. By breaking down barriers to trade and encouraging the exchange of goods and services across borders, it has facilitated the spread of ideas and the growth of industries around the world. As a result, many countries have seen improvements in their standards of living and increased access to goods and services that were previously unavailable.

Which of the following, if true, most weakens the argument?

- A. Globalisation has led to the exploitation of workers in developing countries who are paid very low wages and work in unsafe conditions to produce goods for consumers in wealthier countries.
- B. Globalisation has led to the destruction of traditional industries and ways of life in some countries, resulting in social and economic upheaval.
- C. Globalisation has increased income inequality both within and between countries, as the benefits of globalisation tend to accrue to those who are already wealthy and powerful.
- D. Globalisation has led to increased political stability and cooperation among nations, reducing the likelihood of conflict and war.



22 Shown below are the codes used by Chand and Gean indicated by the colour of the ink which is written on the paper. They use this so that no one knows what they are talking about.

	A	B	C	D	E	F	G	H	I	J	K	L	M	N	O	P	Q	R	S	T	U	V	W	X	Y	Z
B	Q	W	E	R	T	Y	U	I	O	P	A	S	D	F	G	H	J	K	L	Z	X	C	V	B	N	M
R	Z	X	C	V	B	N	M	L	K	J	H	G	F	D	S	A	Q	W	E	R	T	Y	U	I	O	P
G	A	S	D	F	G	H	J	K	L	M	N	B	V	C	X	Z	P	O	I	U	Y	T	R	E	W	Q
P	M	N	B	V	C	X	Z	A	S	D	F	G	H	J	K	L	U	Y	I	O	P	Q	W	E	R	T

B = Blue Ink  
 R = Red Ink  
 G = Green Ink  
 P = Pink Ink

I LOVE YOU, for example, would be written as O SGCT NGX in blue ink, K GSYB OST in red ink, L BXTG WXY in green ink, and S GKQC RKP in pink ink.

Chand gave a note to Gean that reads: **GBR TE BZR GTDCL RSMBRLBW**

In what colour ink did Reyman write this note?

- A. Pink
- B. Blue
- C. Green
- D. Red

23 Which figure is a rotation of the object?

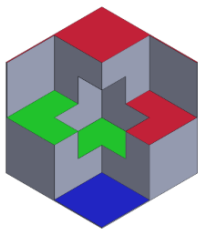

A.

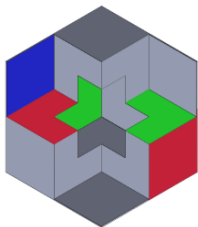

B.

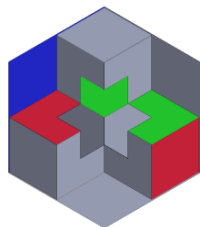

C.

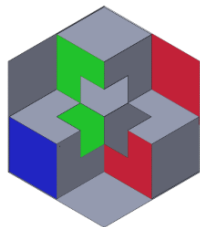

D.

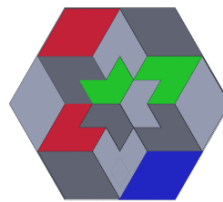

- 24 Maria started selling different kinds of fruits. The table below shows details of the wholesale costs and retail prices for a number of the items sold.

FRUITS	WHOLESALE COST (10 PCS)	RETAIL SELLING (PER PC)	NUMBER SOLD IN A DAY
APPLE	\$240	\$48	30
ORANGE	\$275	\$45	28
WATERMELON	\$290	\$54	35
BANANA	\$210	\$58	21
PINEAPPLE	\$235	\$52	23

Of the five fruits sold by Maria, which two together made the most profit?

- A. Apple and Orange
  - B. Watermelon and Orange
  - C. Banana and Watermelon
  - D. Pineapple and Banana
- 25 Visitors to the Anjo World theme park have two types of tickets available to them, as follows.  
Two types of tickets are available in Universal Studios:
- 1-day ticket – This is valid on the day of issue only.
  - 3-day ticket – This is valid on the day of issue and the next two days only.

This is a record of the tickets issued last week.

	1-DAY	3-DAY
MONDAY	620	123
TUESDAY	567	456
WEDNESDAY	453	734
THURSDAY	577	456
FRIDAY	544	623
SATURDAY	875	567
SUNDAY	932	734

A 1-day ticket costs \$6.  
A 3-day ticket costs \$10

How many tickets altogether were valid for use on Friday last week and how much do all these tickets cost?

- A. 2257 tickets that cost \$21,394
- B. 2257 tickets that cost \$29,394
- C. 2357 tickets that cost \$21,394
- D. 2357 tickets that cost \$29,394

- 26 It is important to have a deep understanding of oneself in order to lead a fulfilling life. By understanding our own emotions, motivations, and values, we can make better decisions, improve our relationships, and achieve our goals. Self-reflection and introspection are crucial tools for gaining this understanding, and it is essential that we take the time to explore our inner selves.

Which of the following, if true, most weakens the argument?

- A. People who focus too much on themselves tend to become self-absorbed and alienate others.
- B. Research has shown that personality traits are largely genetic and cannot be changed through self-reflection.
- C. People who have a strong sense of self-awareness tend to be more anxious and prone to negative thoughts and emotions.
- D. People who have a deep understanding of themselves tend to be more successful in their personal and professional lives.

- 27 A basketball game was organised wherein five reserves alternate equally with each player on the court. One of the main goals of the said game was everybody should be given the same number of minutes on the court. They decided that the game would only last for 2 hours.

How many minutes should each player be given?

- A. 12 minutes
- B. 11 minutes
- C. 24 minutes
- D. 25 minutes

- 28 In this puzzle, assume that the trains arrive at their destination precisely on time.

My sister usually leaves school at 5:00 pm, then catches the 5:30 pm train which arrives at our local station at 6:00. I leave home each day, drive to the station to pick up my sister at 6:00 pm, just as she gets off the train.

One day, my sister was able to finish five minutes earlier than usual, decided to go straight to the station and managed to catch the 5:00 pm train, which arrived at our local station at 5:30 pm. Because I was not there to pick her up, she began to walk home. I left home at the usual time, saw my sister walking, turned around and picked her up and drove home, arriving there 10 minutes earlier than usual.

For how long did my sister walk before I picked her up?

- A. 5 minutes
- B. 10 minutes
- C. 20 minutes
- D. 25 minutes

29 Space exploration is a crucial endeavour that has led to significant advancements in science and technology. The exploration of space has enabled the development of new materials and technologies that have improved our daily lives. Additionally, space exploration has the potential to provide insights into the origins of our universe and the search for life beyond Earth. The benefits of space exploration extend beyond scientific discovery and into the economic sector, creating job opportunities and stimulating economic growth. Despite its cost, space exploration remains a necessary endeavour to advance our understanding of the universe and improve our daily lives.

Which of the following, if true, most strengthens the argument?

- A. Research conducted on the International Space Station has led to the development of new medical treatments that would not have been possible without access to microgravity conditions.
- B. Private companies such as SpaceX have made significant investments in space exploration, indicating that it is a profitable industry.
- C. The cost of space exploration accounts for less than 1% of the federal budget, indicating that it is not a significant drain on resources.
- D. Space exploration has led to the development of new technologies that have improved the efficiency of various industries, such as communication and transportation.

30 Coffee is one of the most consumed drinks all over the world. Aside from tasting good, it also offers various benefits to the body. It contains antioxidants which help your body fight infections and other illnesses. It also provides caffeine which truly helps employees and college students who need to do tasks at night. Despite these benefits, coffee could also pose heart risks when consumed at excessively high levels.

Which among the following shows the main conclusion of the passage?

- A. Coffee tastes good and it allows hardworking employees and students to finish their job.
- B. Coffee is being consumed by students at an excessive level which calls for a ban.
- C. Coffee might be good for the body but it should be consumed at a moderate pace only.
- D. Coffee's antioxidants are an effective benefit for fighting infections and other illnesses.

31 Nicole sent a message to Joseph in an encrypted code. She used pictures rather than letters. Joseph knows that the following symbols represent the word "BEAT."

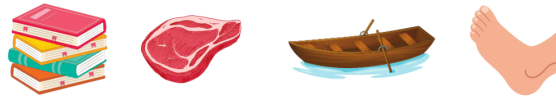

What do these symbols represent?



- A. PHONE
- B. HAPPY
- C. SHOES
- D. CANDY

- 32 The distribution of sales for 5 school supplies are shown in the table below. Use the data to identify which of the four pie charts best represents the sales distribution.

School Supplies	Sales
Ruler	350
Marker	400
Notebook	300
Pencil	480
Eraser	470

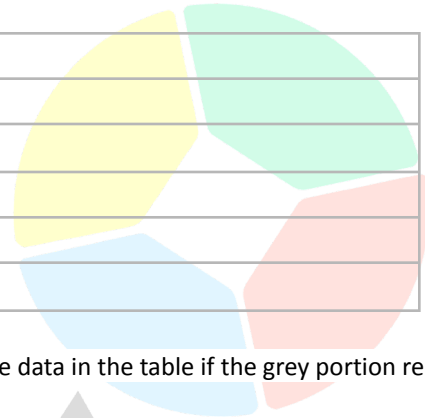

Which one of these four graphs shows the correct representation of the data in the table if the grey portion represents Notebook?



A.



B.



C.



D.

- 33 Natural disasters can strike at any time and can cause widespread damage and loss of life. It is important for individuals and communities to be prepared for such events to minimise the impact of these disasters. Emergency preparedness measures include developing evacuation plans, stockpiling supplies, and practising emergency drills. By being prepared, individuals and communities can reduce the risk of injury, death, and property damage during natural disasters.

Which of the following, if true, best strengthens the argument?

- Following the devastating Hurricane Katrina in New Orleans, cities across the United States have increased their funding for emergency preparedness measures.
- Many individuals in areas prone to earthquakes do not have emergency kits with essential supplies such as food, water, and first aid kits.
- Emergency preparedness measures can also include retrofitting buildings and infrastructure to make them more resilient to natural disasters.
- Communities with established emergency preparedness programs tend to recover more quickly after natural disasters than those without such programs.

34 Social media has become an increasingly pervasive aspect of modern life. While social media platforms can facilitate communication and provide a sense of community, they also have negative effects on mental health. Studies have shown that heavy social media use is associated with higher levels of anxiety, depression, and loneliness. Moreover, the use of social media can lead to the development of unhealthy and unrealistic expectations and standards.

Which of the following best summarises the main point of the passage?

- A. Social media has positive and negative effects on mental health.
- B. Heavy social media use is associated with higher levels of anxiety, depression, and loneliness.
- C. The use of social media can lead to the development of unhealthy and unrealistic expectations and standards.
- D. Social media is a pervasive aspect of modern life that facilitates communication and provides a sense of community.

35 A staircase is made from 220 cubes fitted tightly together in the arrangement below.

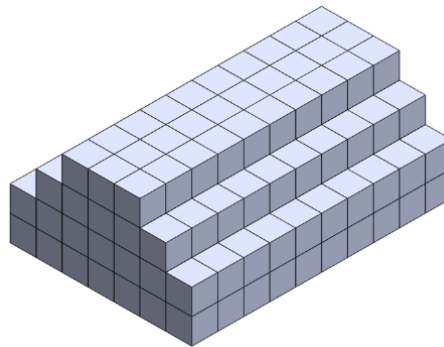

The cube is fully immersed in quick-drying paint. All the exposed faces become covered in paint, but the inner ones remain unpainted.

How many cubes have at least one side painted?

- A. 136
- B. 148
- C. 156
- D. 164

- 36 Jason, a medical technologist is planning to file a 2-day vacation leave this week on Sunday and Monday. Protocol says that he can only do so if somebody covers his 8-hour shift provided that they must not have a gap of less than 12 hrs from the last duty period. Upon looking at the laboratory's schedule, he found this.

	SUNDAY	MONDAY	TUESDAY	WEDNESDAY	THURSDAY	FRIDAY	SATURDAY
VHON	P	O	P	N	N	O	A
JASON	A	A	O	C	N	O	P
CLENETTE	O	C	O	B	A	P	N
ANGELO	N	O	A	N	O	A	A
NICOLE	N	N	O	P	O	A	A
JEANNE	A	O	N	P	P	P	O

THE DUTY SCHEDULE:

- A – 6am – 2pm
- P – 2pm – 10pm
- N – 10pm – 6am
- B – 6am – 6pm
- C – 6pm – 6am
- O – OFF DUTY

Who cares for Jason on his 2-day vacation leave?

- A. Angelo and Nicole
  - B. Jeanne and Vhon
  - C. Clenette and Jeanne
  - D. Angelo and Clenette
- 37 Three friends, Kahil, Marco, and Yani, are trying to figure out each other's ages. Kahil gives a hint: "If you add my age to Marco's age and then subtract Yani's age, you'll get 50." Marco adds another clue: "If you add my age to Yani's age and then subtract Kahil's age, you'll get 46." Finally, Yani offers a final hint: "If you add my age to Kahil's age and then subtract Marco's age, you'll get 48."

Which of the following is true?

- A. Kahil is 48 years old.
- B. Marco is 48 years old.
- C. Yani is 55 years old.
- D. Kahil is 47 years old.

- 38** Studies show that regular exercise can help improve overall health and reduce the risk of chronic diseases such as heart disease and diabetes. Some people argue that exercise can be harmful, especially for older adults, due to the risk of injury or strain on the body.

**Which statement, if true, best weakens the argument that exercise can be harmful?**

- A. Exercise should be avoided by older adults altogether, as the risk of injury or strain on the body is too high.
- B. The benefits of exercise, such as improved cardiovascular health and mental well-being, far outweigh the risks associated with exercise-related injuries.
- C. While exercise can lead to injuries, the majority of injuries are caused by accidents or improper technique, rather than the exercise itself.
- D. Exercise, when done properly and with proper guidance, can actually help reduce the risk of injury and strain on the body by improving strength and flexibility.

- 39** Bianca, Loren, Gigi, Kat, and Liz all practised to compete in a scrabble tournament and each put in \$30 in a box. After 5 consecutive games, the person who gets the highest total points would claim the money. The table shows their scores after 5 games:

	Bianca	Loren	Gigi	Kat	Liz
Game 1	505	507	510	485	474
Game 2	465	508	520	530	545
Game 3	570	358	378	562	544
Game 4	540	490	610	585	430
Game 5	375	480	385	610	590

**Who won the \$150 prize pool?**

- A. Bianca
- B. Loren
- C. Gigi
- D. Kat

- 40** Five friends – Alex, Ben, Chris, David, and Eric – have been attending a maths class together. Their maths teacher has just handed out the graded exams and told them the following:

- At most one of the students in the class got an A.
- Alex did not get an A.
- Ben and Chris both got the same grade.
- David got a better grade than Eric but a lower grade than Ben and Chris.

**Who got the A grade?**

- A. Ben
- B. David
- C. Eric
- D. None of them